

Lösungen zu Automaten – nach Klett-BuchBuch, S.27, 1.

a)

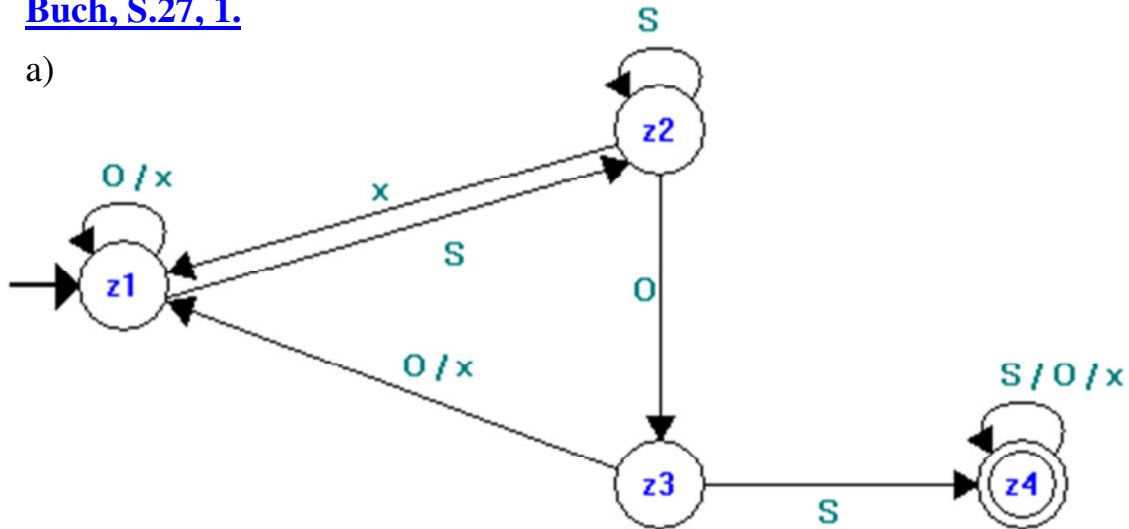

b)

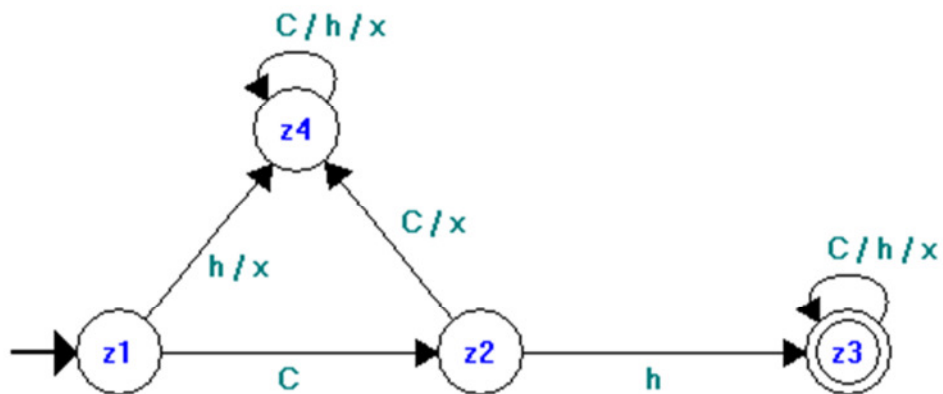

c)

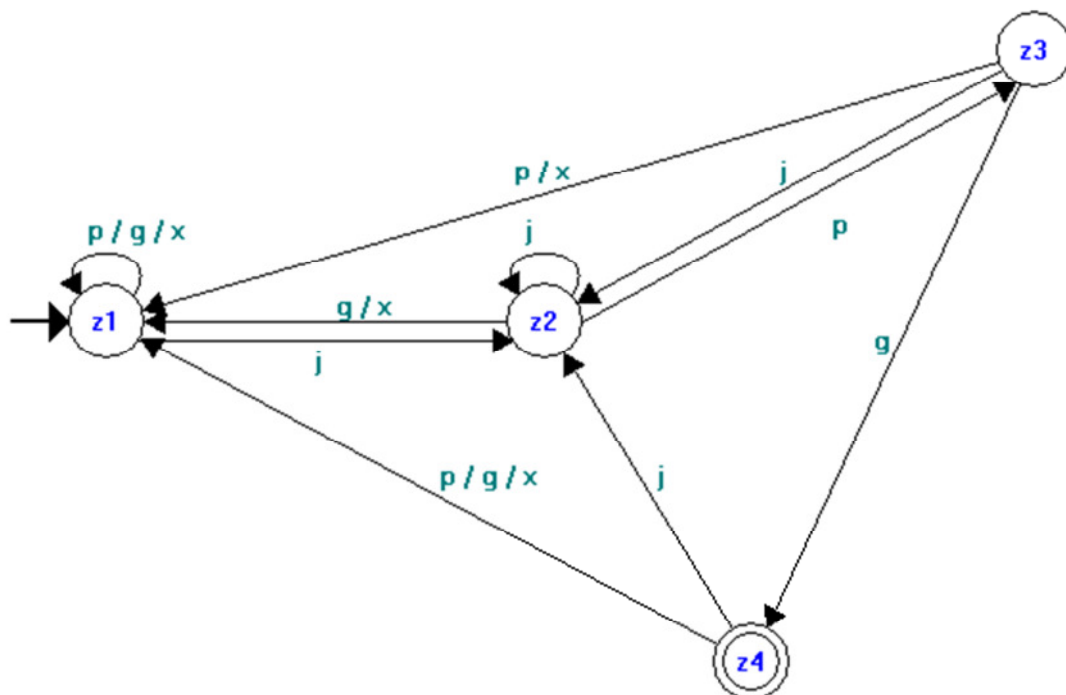

d)

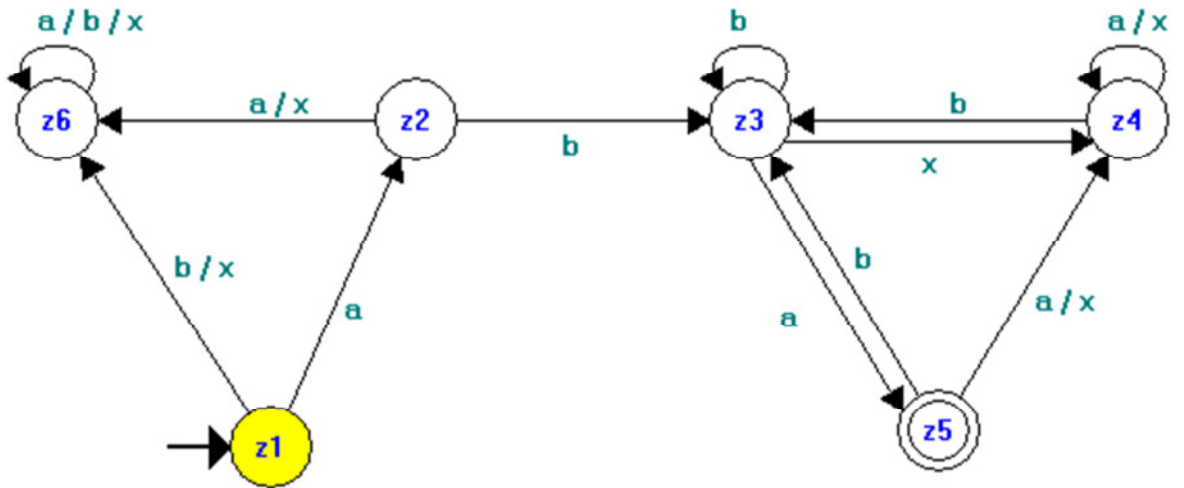

e)

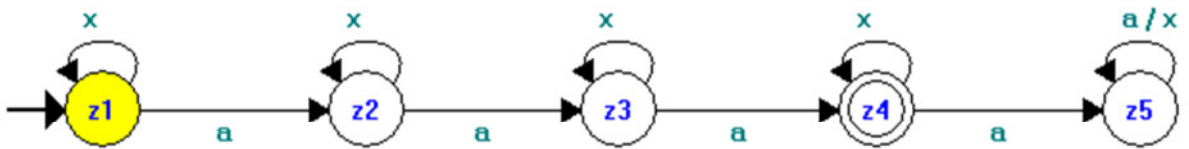

f)

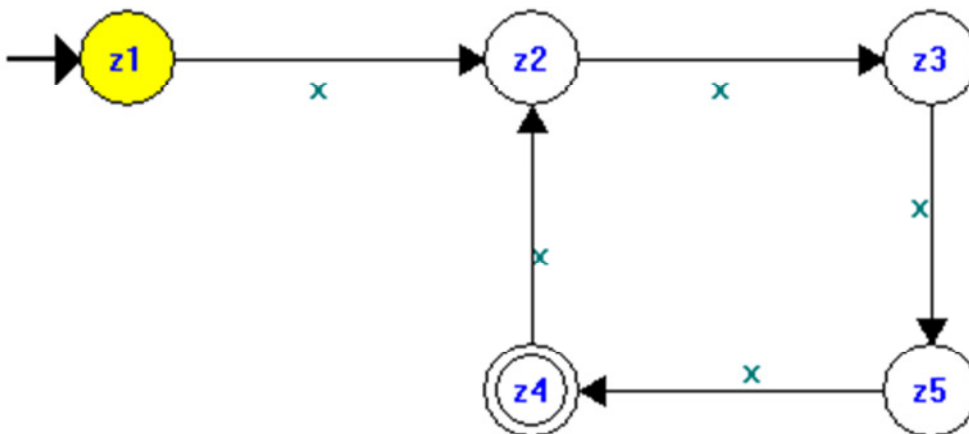
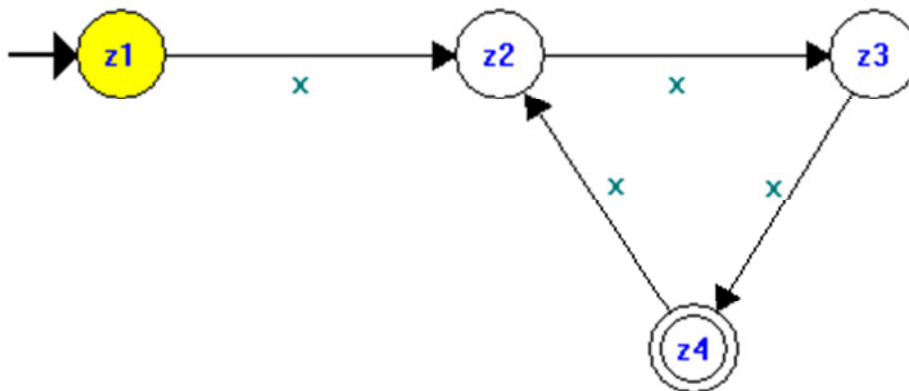

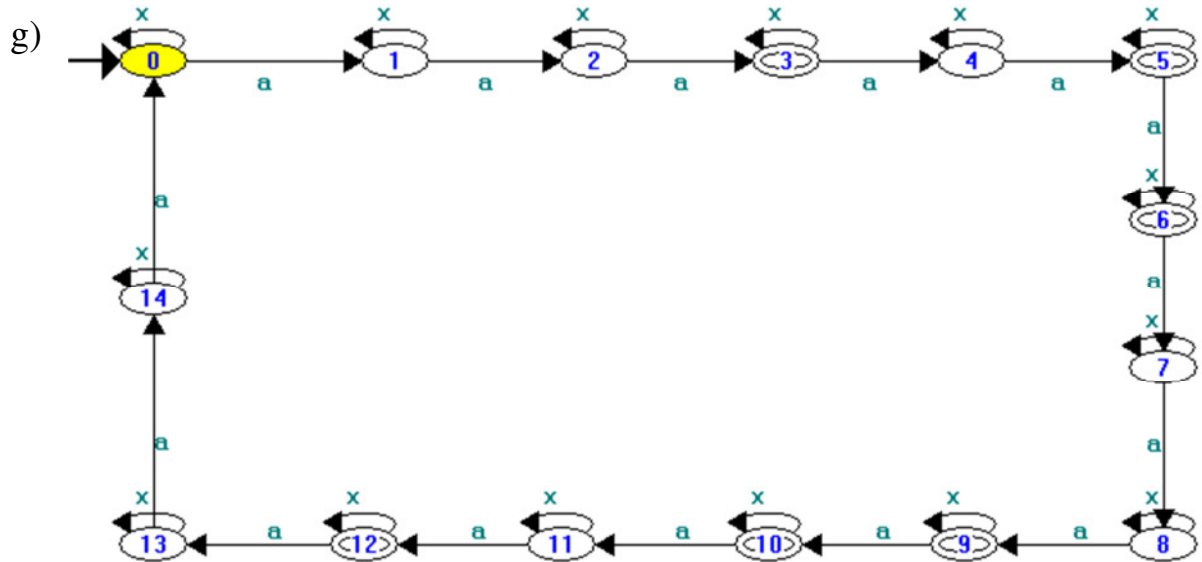

Buch, S.27, 4.

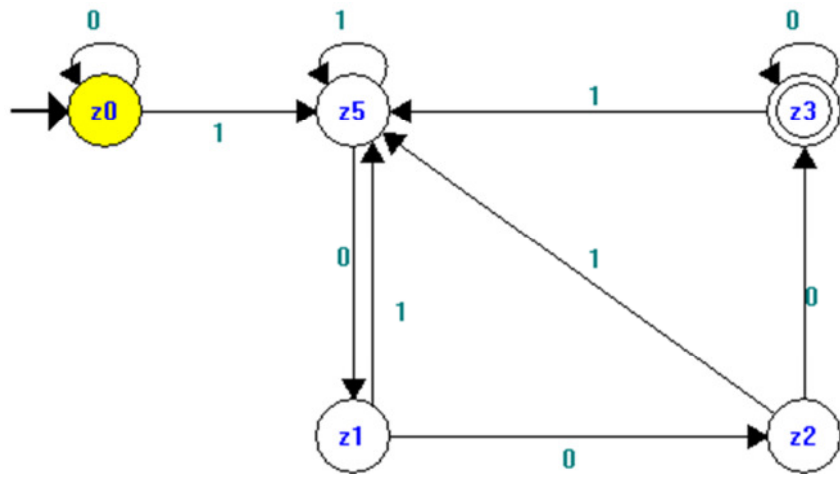

Automat, Teilbarkeit durch 6:

